



CASE
CONSTRUCTION

E SERIES WHEELED EXCAVATORS



WX140E | WX160E

SPECIFICATIONS

WX140E

ENGINE

Model _____ Cummins B4.5
Type _____ Water-cooled, 4-cycle diesel, 4-cylinder in line,
High pressure common rail system (electric control),
turbocharger with air cooled intercooler, DOC+DPF+SCR,
EGR free.
Emissions _____ Stage V
Number of cylinders / Displacement (l) _____ 4 / 4.5
Bore and stroke (mm) _____ 107 x 124
Rated flywheel horse power
ISO 9249 (kW) _____ 127 at 2200 min⁻¹ (rpm)
ISO 14396 (kW) _____ 129 at 2200 min⁻¹ (rpm)
Maximum torque
ISO 14396 (Nm) _____ 780 at 1500 min⁻¹ (rpm)

HYDRAULIC SYSTEM

Main pump _____ Variable displacement piston pump
Max. oil flow (l/min) _____ 230 at 1600 min⁻¹
Working circuit pressure
Boom/Arm/Bucket (MPa) _____ 34.3 - 37.3 with auto power boost
Swing circuit (MPa) _____ 26.5
Travel circuit (MPa) _____ 37.3
Pilot circuit (MPa) _____ 3.9
Boom cylinders
Bore (mm) _____ 105
Stroke (mm) _____ 1105
Boom positioning (2 piece boom only)
Bore (mm) _____ 145
Stroke (mm) _____ 634
Arm cylinder
Bore (mm) _____ 115
Stroke (mm) _____ 1138
Bucket cylinder
Bore (mm) _____ 100
Stroke (mm) _____ 850

SWING

Swing motor _____ Fixed displacement radial piston motor
Maximum swing speed (min⁻¹) _____ 9.5
Swing torque (Nm) _____ 31,600
Brake system _____ Automatic, spring applied
hydraulic released

ELECTRICAL SYSTEM

Voltage (V) _____ 24
Alternator (Amp) _____ 95
Starter (V - kW) _____ 24 - 4.8
Battery _____ 2 X 12 V 100 Ah

STEERING

Type _____ Orbitrol steering system
Minimum turning radius (m) _____ 6.3

AXLES

Type _____ 4 wheel drive with differential, oscillating front axle
with automatic or operator controlled oscillation lock,
fixed rear axle
Brake type _____ Wet multi-disc
Parking brake type _____ Wet multi-disc integrated
in transmission

UNDERCARRIAGE

Transmission _____ 2 speed hydrostatic powershift
Travel motor _____ Variable displacement bent-axis axial
piston motor
High travel speed (Automatic travel speed shifting) (km/h) _____ 40
Low travel speed (km/h) _____ 10
Creep speed (km/h) _____ 3
Drawbar pull (kN) _____ 80
Gradeability _____ 58% (30°)

NOISE

External guaranteed sound level
(EU Directive 2000/14/EC) _____ LwA 96 dB(A)
Operator cab sound pressure level (ISO 6396) _____ LpA 71 dB(A)

CIRCUIT AND COMPONENT CAPACITIES

Fuel tank (l) _____ 250
Hydraulic system (l) _____ 204
Hydraulic tank (l) _____ 122
AdBlue tank (l) _____ 48

DIMENSIONS

WX140E MONO

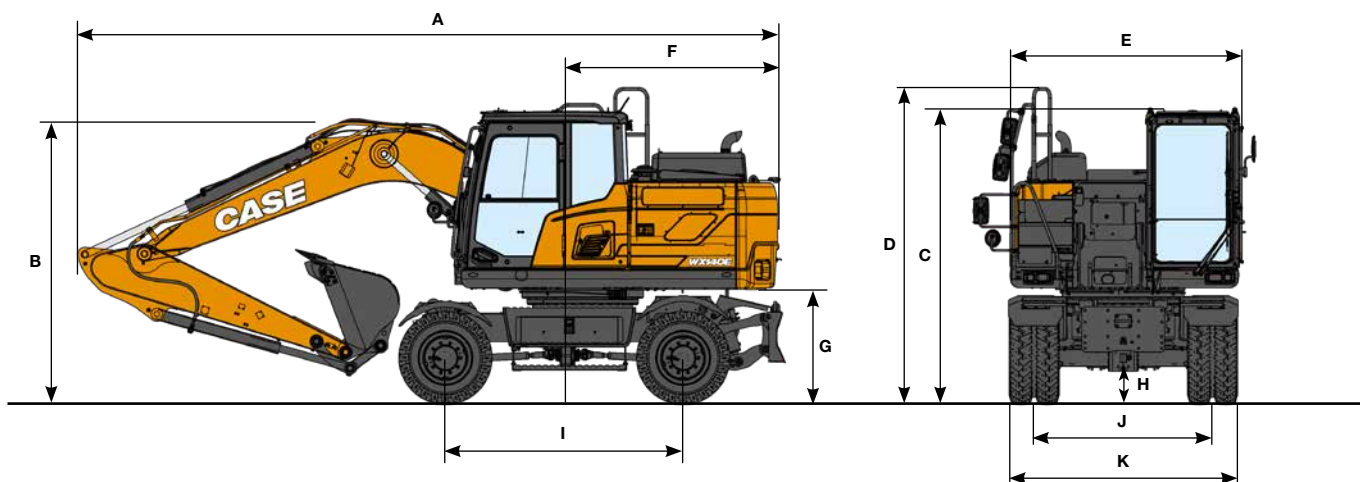

GENERAL DIMENSIONS		Arm 2.45 m	Arm 2.00 m	Arm 2.60 m	Arm 3.10 m
A Overall length (with attachment) (traveling/transportation)	mm	7560 / 7495	7740 / 7675	7470 / 7405	7365 / 7300
B Overall height (to top of boom) (traveling/transportation)	mm	3655 / 2930	3270 / 2720	3775 / 3050	3990 / 3420
C Cab height	mm	3255	3255	3255	3255
D Overall height (to top of handrail)	mm	3475	3475	3475	3475
E Upper structure overall width	mm	2485	2485	2485	2485
F Swing (rear end) radius	mm	2170	2170	2170	2170
G Clearance height under upper structure	mm	1260	1260	1260	1260
H Minimum ground clearance	mm	390	390	390	390
I Wheel base (center to center of wheels)	mm	2600	2600	2600	2600
J Tread	mm	1944	1944	1944	1944
K Undercarriage overall width	mm	2530	2530	2530	2530

WEIGHT

With 2.45 m arm, 0.58 m³ bucket, 10.00×20 twin tires, standard counterweight, operator, lubricant, coolant, full fuel tank.

MONO	WEIGHT
Rear blade	14900 kg
Front blade and rear stabilizers	15830 kg

Std counterweight: 1700 kg
Heavy counterweight: 1700 kg + 500 kg

PERFORMANCE DATA		Arm 2.45 m	Arm 2.00 m	Arm 2.60 m	Arm 3.10 m
Boom length	mm	4600	4600	4600	4600
A Maximum reach at GRP	mm	8080	7640	8230	8700
B Maximum reach	mm	8310	7880	8450	8910
C Max. digging depth	mm	5110	4660	5260	5760
D Max. digging height	mm	8850	8540	8940	9210
E Max. dumping height	mm	6400	6100	6490	6760
F Min. swing radius	mm	2680	2670	2690	2720

DIGGING FORCE (ISO 6015)		Arm 2.45 m	Arm 2.00 m	Arm 2.60 m	Arm 3.10 m
Arm digging force	kN	66	78	64	57
with Auto power up	kN	72	85	69	62
Bucket digging force	kN	103	103	103	103
with Auto power up	kN	112	112	112	112

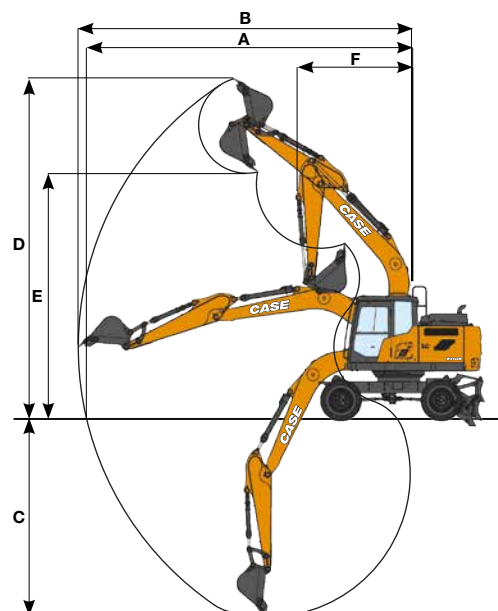









LIFTING CAPACITY

WX140E MONO

		REACH										
		1.5 m		3.0 m		4.5 m		6.0 m		At max reach		m
Front	Side											
REAR BLADE DOWN - Mono boom 4.6 m, arm 2.00 m, 1700 kg counterweight												
6.0 m						4420*	3670			3330*	2910	5.15
4.5 m						4790*	3570	3560	2240	3110*	2190	6.08
3.0 m						5500	3350	3490	2180	3050	1900	6.53
1.5 m						5250	3140	3400	2090	2940	1810	6.62
0 m				6510*	5520	5120	3020	3340	2040	3090	1890	6.34
-1.5 m	6490*	6490*		9460*	5580	5120	3020			3650	2230	5.66
-3.0 m				6990*	5760					4600*	3300	4.37
REAR BLADE UP - Mono boom 4.6 m, arm 2.00 m, 1700 kg counterweight												
6.0 m						4420*	3330			3330*	2640	5.15
4.5 m						4790*	3230	3560	2020	3110*	1970	6.08
3.0 m						5500	3010	3490	1960	3050	1710	6.53
1.5 m						5250	2810	3400	1880	2940	1620	6.62
0 m				6510*	4840	5120	2700	3340	1820	3090	1700	6.34
-1.5 m	6490*	6490*		9460*	4900	5120	2690			3650	1990	5.66
-3.0 m				6990*	5080					4600*	2950	4.37
REAR BLADE DOWN - Mono boom 4.6 m, arm 2.45 m, 1700 kg counterweight												
7.5 m										2890*	2890*	4.16
6.0 m						3880*	3740			2390*	2390*	5.70
4.5 m						4330*	3620	3590	2270	2250*	1940	6.55
3.0 m				7850*	6310	5330*	3390	3500	2180	2260*	1700	6.97
1.5 m				5690*	5650	5270	3150	3390	2080	2410*	1630	7.05
0 m				6760*	5460	5100	3000	3310	2010	2740*	1690	6.79
-1.5 m	5600*	5600*		9980*	5480	5060	2960	3300	2000	3190	1940	6.16
-3.0 m				7990*	5620	5160	3050			4400	2650	5.01
REAR BLADE UP - Mono boom 4.6 m, arm 2.45 m, 1700 kg counterweight												
7.5 m										2890*	2890*	4.16
6.0 m						3880*	3390			2390*	2250	5.70
4.5 m						4330*	3280	3590	2050	2250*	1750	6.55
3.0 m				7850*	5600	5330*	3050	3500	1970	2260*	1530	6.97
1.5 m				5690*	4970	5270	2810	3390	1860	2410*	1460	7.05
0 m				6760*	4790	5100	2670	3310	1790	2740*	1510	6.79
-1.5 m	5600*	5600*		9980*	4800	5060	2640	3300	1790	3190	1730	6.16
-3.0 m				7990*	4940	5160	2720			4400	2370	5.01
FRONT BLADE & REAR STABILIZERS DOWN - Mono boom 4.6 m, arm 2.45 m, 1700 kg counterweight												
7.5 m										2890*	2890*	4.16
6.0 m						3890*	3890*			2390*	2390*	5.70
4.5 m						4330*	4330*	3800*	3800*	2250*	2250*	6.55
3.0 m				7850*	7850*	5330*	5330*	4400*	3770	2270*	2270*	6.97
1.5 m				5690*	5690*	6370*	5680	4830*	3660	2410*	2410*	7.05
0 m				6760*	6760*	6900*	5510	5060*	3580	2740*	2740*	6.79
-1.5 m	5600*	5600*		9980*	9980*	6700*	5470	4720*	3580	3430*	3430*	6.16
-3.0 m				7990*	7990*	5350*	5350*			4460*	4460*	5.01
FRONT BLADE & REAR STABILIZERS UP - Mono boom 4.6 m, arm 2.45 m, 1700 kg counterweight												
7.5 m										2890*	2890*	4.16
6.0 m						3890*	3890*			2390*	2390*	5.70
4.5 m						4330*	4160	3690	2630	2250*	2250*	6.55
3.0 m				7850*	7370	5330*	3930	3590	2540	2270*	2000	6.97
1.5 m				5690*	5690*	5410	3680	3480	2440	2410*	1920	7.05
0 m				6760*	6490	5240	3530	3400	2360	2740*	1990	6.79
-1.5 m	5600*	5600*		9980*	6500	5200	3490	3400	2360	3280	2280	6.16
-3.0 m				7990*	6660	5290	3580			4460*	3100	5.01
REAR BLADE DOWN - Mono boom 4.6 m, arm 2.60 m, 1700 kg counterweight												
7.5 m										2660*	2660*	4.40
6.0 m										2230*	2230*	5.87
4.5 m						4180*	3650	3610	2280	2100*	1870	6.70
3.0 m				7510*	6380	5190*	3410	3510	2190	2110*	1650	7.12
1.5 m				6430*	5680	5280	3150	3390	2080	2250*	1580	7.19
0 m				6820*	5440	5090	2990	3300	2000	2540*	1630	6.94
-1.5 m	5360*	5360*		10110*	5440	5040	2950	3290	1990	3060	1860	6.33
-3.0 m	9520*	9520*		8270*	5580	5120	3020			4130	2490	5.21
REAR BLADE UP - Mono boom 4.6 m, arm 2.60 m, 1700 kg counterweight												
7.5 m										2660*	2660*	4.40
6.0 m										2230*	2140	5.87
4.5 m						4180*	3300	3610	2060	2100*	1690	6.70
3.0 m				7510*	5670	5190*	3070	3510	1970	2110*	1480	7.12
1.5 m				6430*	5000	5280	2820	3390	1870	2250*	1410	7.19
0 m				6820*	4770	5090	2660	3300	1790	2540*	1460	6.94
-1.5 m	5360*	5360*		10110*	4760	5040	2620	3290	1770	3060	1660	6.33
-3.0 m	9520*	9520*		8270*	4900	5120	2690			4130	2220	5.21

* The above loads (kg) are compliant to the ISO standards and refer to the excavator equipped without bucket. The indicated loads are no more than 87% of hydraulic system lift capacity or 75% of static tipping load. Values marked with an asterisk (*) are limited by the hydraulic lifting capacity.

REACH													
Front Side	1.5 m		3.0 m		4.5 m		6.0 m		7.5 m		At max reach		m
													

REAR BLADE DOWN - Mono boom 4.6 m, arm 3.10 m, 1700 kg counterweight

7.5 m											2150*	2150*	5.13
6.0 m							2670*	2340			1860*	1860*	6.43
4.5 m							3310*	2310			1770*	1660	7.20
3.0 m			6350*	6350*	4690*	3470	3530	2210	2090*	1510	1790*	1480	7.58
1.5 m			9370*	5840	5330	3190	3400	2080	2400	1460	1900*	1410	7.65
0 m			7170*	5460	5100	2990	3290	1980			2120*	1450	7.42
-1.5 m	4710*	4710*	9570*	5380	5010	2910	3240	1940			2570*	1620	6.85
-3.0 m	7920*	7920*	9090*	5470	5040	2940					3430	2070	5.84

REAR BLADE UP - Mono boom 4.6 m, arm 3.10 m, 1700 kg counterweight

7.5 m											2150*	2150*	5.13
6.0 m							2670*	2120			1860*	1850	6.43
4.5 m							3310*	2090			1770*	1490	7.20
3.0 m			6350*	5900	4690*	3130	3530	1990	2090*	1350	1790*	1320	7.58
1.5 m			9370*	5150	5330	2860	3400	1870	2400	1310	1900*	1260	7.65
0 m			7170*	4780	5100	2660	3290	1770			2120*	1290	7.42
-1.5 m	4710*	4710*	9570*	4710	5010	2580	3240	1730			2570*	1440	6.85
-3.0 m	7920*	7920*	9090*	4790	5040	2610					3430	1840	5.84

REAR BLADE DOWN - Mono boom 4.6 m, arm 2.0 m, 2200 kg counterweight

7.5 m													
6.0 m					4420*	4000					3330*	3180	5.15
4.5 m					4790*	3890	3600*	2460			3110*	2410	6.08
3.0 m					5740*	3670	3780	2400			3140*	2100	6.53
1.5 m					5680	3460	3680	2320			3190	2010	6.62
0 m			6510*	6090	5550	3350	3620	2260			3350	2100	6.34
-1.5 m	6490*	6490*	9460*	6150	5540	3340					3960	2470	5.66
-3.0 m			6990*	6340							4600*	3630	4.37

REAR BLADE UP - Mono boom 4.6 m, arm 2.0 m, 2200 kg counterweight

7.5 m													
6.0 m					4420*	3630					3330*	2900	5.15
4.5 m					4790*	3540	3600*	2240			3110*	2190	6.08
3.0 m					5740*	3320	3780	2180			3140*	1900	6.53
1.5 m					5680	3110	3680	2090			3190	1820	6.62
0 m			6510*	5380	5550	3000	3620	2040			3350	1900	6.34
-1.5 m	6490*	6490*	9460*	5430	5540	3000					3960	2220	5.66
-3.0 m			6990*	5610							4600*	3270	4.37

REAR BLADE DOWN - Mono boom 4.6 m, arm 2.45 m, 2200 kg counterweight

7.5 m											2890*	2890*	4.16
6.0 m					3880*	3880*					2390*	2390*	5.70
4.5 m					4330*	3940	3790*	2490			2250*	2140	6.55
3.0 m			7850*	6880	5330*	3710	3790	2410			2260*	1890	6.97
1.5 m			5690*	5690*	5700	3470	3670	2300			2410*	1810	7.05
0 m			6760*	6030	5530	3320	3590	2230			2740*	1880	6.79
-1.5 m	5600*	5600*	9980*	6050	5490	3290	3590	2230			3430*	2150	6.16
-3.0 m			7990*	6200	5350*	3370					4450*	2930	5.01

REAR BLADE UP - Mono boom 4.6 m, arm 2.45 m, 2200 kg counterweight

7.5 m											2890*	2890*	4.16
6.0 m					3880*	3700					2390*	2390*	5.70
4.5 m					4330*	3580	3790*	2260			2250*	1940	6.55
3.0 m			7850*	6130	5330*	3360	3790	2180			2260*	1710	6.97
1.5 m			5690*	5510	5700	3120	3670	2080			2410*	1630	7.05
0 m			6760*	5320	5530	2980	3590	2010			2740*	1690	6.79
-1.5 m	5600*	5600*	9980*	5330	5490	2940	3590	2000			3430*	1940	6.16
-3.0 m			7990*	5480	5350*	3020					4450*	2640	5.01

* The above loads (kg) are compliant to the ISO standards and refer to the excavator equipped without bucket. The indicated loads are no more than 87% of hydraulic system lift capacity or 75% of static tipping load. Values marked with an asterisk (*) are limited by the hydraulic lifting capacity.

LIFTING CAPACITY

WX140E MONO

		REACH												
Front Side		1.5 m		3.0 m		4.5 m		6.0 m		7.5 m		At max reach		m
														

REAR BLADE DOWN - Mono boom 4.6 m, arm 2.60 m, 2200 kg counterweight

7.5 m												2660*	2660*	4.40
6.0 m												2230*	2230*	5.87
4.5 m						4180*	3970	3720*	2510			2100*	2070	6.70
3.0 m				7510*	6950	5190*	3730	3800	2420			2110*	1830	7.12
1.5 m				6430*	6250	5710	3480	3680	2310			2250*	1760	7.19
0 m				6820*	6020	5520	3320	3590	2230			2540*	1820	6.94
-1.5 m	5360*	5360*	10110*	6010	5740	3270		3570	2210			3140*	2070	6.33
-3.0 m	9520*	9520*	8270*	6150	5550	3340						4400*	2760	5.21

REAR BLADE UP - Mono boom 4.6 m, arm 2.60 m, 2200 kg counterweight

7.5 m												2660*	2660*	4.40
6.0 m												2230*	2230*	5.87
4.5 m						4180*	3610	3720*	2280			2100*	1870	6.70
3.0 m				7510*	6200	5190*	3380	3800	2190			2110*	1660	7.12
1.5 m				6430*	5530	5710	3130	3680	2080			2250*	1580	7.19
0 m				6820*	5300	5520	2970	3590	2000			2540*	1640	6.94
-1.5 m	5360*	5360*	10110*	5300	5740	2930		3570	1990			3140*	1860	6.33
-3.0 m	9520*	9520*	8270*	5430	5550	3000						4400*	2480	5.21

REAR BLADE DOWN - Mono boom 4.6 m, arm 3.10 m, 2200 kg counterweight

7.5 m												2150*	2150*	5.13
6.0 m								2670*	2570			1860*	1860*	6.43
4.5 m								3310*	2530			1770*	1770*	7.20
3.0 m				6350*	6350*	4690*	3800	3820	2430	2090*	1680	1790*	1650	7.58
1.5 m				9370*	6410	5760	3520	3680	2310	2510*	1640	1900*	1580	7.65
0 m				7170*	6030	5530	3320	3570	2210			2120*	1630	7.42
-1.5 m	4710*	4710*	9570*	5960	5430	3230		3530	2170			2570*	1810	6.85
-3.0 m	7920*	7920*	9090*	6040	5460	3260						3610*	2300	5.84

REAR BLADE UP - Mono boom 4.6 m, arm 3.10 m, 2200 kg counterweight

7.5 m												2150*	2150*	5.13
6.0 m								2670*	2340			1860*	1860*	6.43
4.5 m								3310*	2300			1770*	1670	7.20
3.0 m				6350*	6350*	4690*	3440	3820	2200	2090*	1520	1790*	1490	7.58
1.5 m				9370*	5680	5760	3170	3680	2080	2510*	1470	1900*	1420	7.65
0 m				7170*	5320	5530	2970	3570	1980			2120*	1460	7.42
-1.5 m	4710*	4710*	9570*	5240	5430	2890		3530	1940			2570*	1630	6.85
-3.0 m	7920*	7920*	9090*	5320	5460	2920						3610*	2060	5.84

* The above loads (kg) are compliant to the ISO standards and refer to the excavator equipped without bucket. The indicated loads are no more than 87% of hydraulic system lift capacity or 75% of static tipping load. Values marked with an asterisk (*) are limited by the hydraulic lifting capacity.

BUCKETS

WX140E MONO

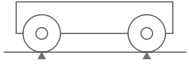

QUICK COUPLED - ON WHEELS

Capacity m ³ (ISO7451 HEAPED)	Width mm	Weight kg	Arm 2.00 m	Arm 2.45 m 2.60 m	Arm 3.10 m
GENERAL PURPOSE BUCKETS					
0.21	450	250	○	○	○
0.31	600	290	○	○	○
0.41	750	330	○	●	●
0.52	900	360	●	▲	■
0.58	1000	400	▲	■	-
0.66	1100	430	■	-	-

Capacity m ³ (ISO7451 HEAPED)	Width mm	Weight kg	Arm 2.00 m	Arm 2.45 m 2.60 m	Arm 3.10 m
HEAVY DUTY BUCKETS					
0.21	450	350	○	○	○
0.31	600	400	○	○	●
0.42	750	460	○	●	■
0.45	800	470	○	●	■
0.52	900	510	●	■	-
0.60	1000	550	■	-	-

Capacity m ³ (ISO7451 HEAPED)	Width mm	Weight* kg	Arm 2.00 m	Arm 2.45 m 2.60 m	Arm 3.10 m
GRADING BUCKETS					
0.59	1500	440	▲	■	-
0.72	1800	510	■	-	-

Capacity m ³ (ISO7451 HEAPED)	Width mm	Weight* kg	Arm 2.00 m	Arm 2.45 m 2.60 m	Arm 3.10 m
DITCH CLEANING BUCKETS					
0.54	1830	480	●	■	-

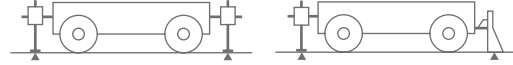

QUICK COUPLED - STABILIZED

Capacity m ³ (ISO7451 HEAPED)	Width mm	Weight kg	Arm 2.00 m	Arm 2.45 m 2.60 m	Arm 3.10 m
GENERAL PURPOSE BUCKETS					
0.21	450	250	○	○	○
0.31	600	290	○	○	○
0.41	750	330	○	●	●
0.52	900	360	●	▲	■
0.58	1000	400	▲	■	■
0.66	1100	430	▲	■	-
0.73	1200	450	■	-	-

Capacity m ³ (ISO7451 HEAPED)	Width mm	Weight kg	Arm 2.00 m	Arm 2.45 m 2.60 m	Arm 3.10 m
HEAVY DUTY BUCKETS					
0.21	450	350	○	○	○
0.31	600	400	○	○	●
0.42	750	460	○	●	▲
0.45	800	470	○	●	■
0.52	900	510	●	▲	■
0.60	1000	550	▲	■	-

Capacity m ³ (ISO7451 HEAPED)	Width mm	Weight* kg	Arm 2.00 m	Arm 2.45 m 2.60 m	Arm 3.10 m
GRADING BUCKETS					
0.59	1500	440	●	▲	■
0.72	1800	510	▲	■	-

Capacity m ³ (ISO7451 HEAPED)	Width mm	Weight* kg	Arm 2.00m	Arm 2.45 m 2.60 m	Arm 3.10 m
DITCH CLEANING BUCKETS					
0.54	1830	480	●	▲	■

○ Rated material density up to 2 ton/m³
● Rated material density up to 1.6 ton/m³

▲ Rated material density up to 1.4 ton/m³
■ Rated material density up to 1.2 ton/m³

— Not applicable
* with bolt-on cutting edge

BUCKETS

WX140E MONO (HEAVY COUNTERWEIGHT)



QUICK COUPLED - ON WHEELS

Capacity m ³ (ISO7451 HEAPED)	Width mm	Weight kg	Arm 2.00 m	Arm 2.45 m 2.60 m	Arm 3.10 m
GENERAL PURPOSE BUCKETS					
0.21	450	250	○	○	○
0.31	600	290	○	○	○
0.41	750	330	○	○	●
0.52	900	360	○	●	▲
0.58	1000	400	●	▲	■
0.66	1100	430	▲	■	-
0.73	1200	450	▲	■	-

Capacity m ³ (ISO7451 HEAPED)	Width mm	Weight kg	Arm 2.00 m	Arm 2.45 m 2.60 m	Arm 3.10 m
HEAVY DUTY BUCKETS					
0.21	450	350	○	○	○
0.31	600	400	○	○	○
0.42	750	460	○	○	●
0.45	800	470	○	●	■
0.52	900	510	○	●	■
0.60	1000	550	●	■	-
0.67	1100	580	■	-	-

Capacity m ³ (ISO7451 HEAPED)	Width mm	Weight* kg	Arm 2.00 m	Arm 2.45 m 2.60 m	Arm 3.10 m
GRADING BUCKETS					
0.59	1500	440	●	▲	■
0.72	1800	510	▲	■	-
0.80	2000	550	■	-	-

Capacity m ³ (ISO7451 HEAPED)	Width mm	Weight* kg	Arm 2.00 m	Arm 2.45 m 2.60 m	Arm 3.10 m
DITCH CLEANING BUCKETS					
0.54	1830	480	○	●	■

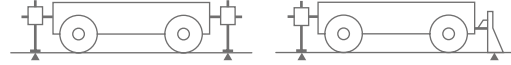

QUICK COUPLED - STABILIZED

Capacity m ³ (ISO7451 HEAPED)	Width mm	Weight kg	Arm 2.00 m	Arm 2.45 m 2.60 m	Arm 3.10 m
GENERAL PURPOSE BUCKETS					
0.21	450	250	○	○	○
0.31	600	290	○	○	○
0.41	750	330	○	○	●
0.52	900	360	○	●	▲
0.58	1000	400	●	▲	▲
0.66	1100	430	▲	■	■
0.73	1200	450	▲	■	-

Capacity m ³ (ISO7451 HEAPED)	Width mm	Weight kg	Arm 2.00 m	Arm 2.45 m 2.60 m	Arm 3.10 m
HEAVY DUTY BUCKETS					
0.21	450	350	○	○	○
0.31	600	400	○	○	○
0.42	750	460	○	○	●
0.45	800	470	○	●	▲
0.52	900	510	○	●	■
0.60	1000	550	●	▲	■
0.67	1100	580	▲	■	-

Capacity m ³ (ISO7451 HEAPED)	Width mm	Weight* kg	Arm 2.00 m	Arm 2.45 m 2.60 m	Arm 3.10 m
GRADING BUCKETS					
0.59	1500	440	○	●	▲
0.72	1800	510	●	▲	■
0.80	2000	550	▲	■	-

Capacity m ³ (ISO7451 HEAPED)	Width mm	Weight* kg	Arm 2.00 m	Arm 2.45 m 2.60 m	Arm 3.10 m
DITCH CLEANING BUCKETS					
0.54	1830	480	○	●	▲

○ Rated material density up to 2 ton/m³
● Rated material density up to 1.6 ton/m³

▲ Rated material density up to 1.4 ton/m³
■ Rated material density up to 1.2 ton/m³

— Not applicable
* with bolt-on cutting edge

SPECIFICATIONS

WX140E 2-PIECE BOOM

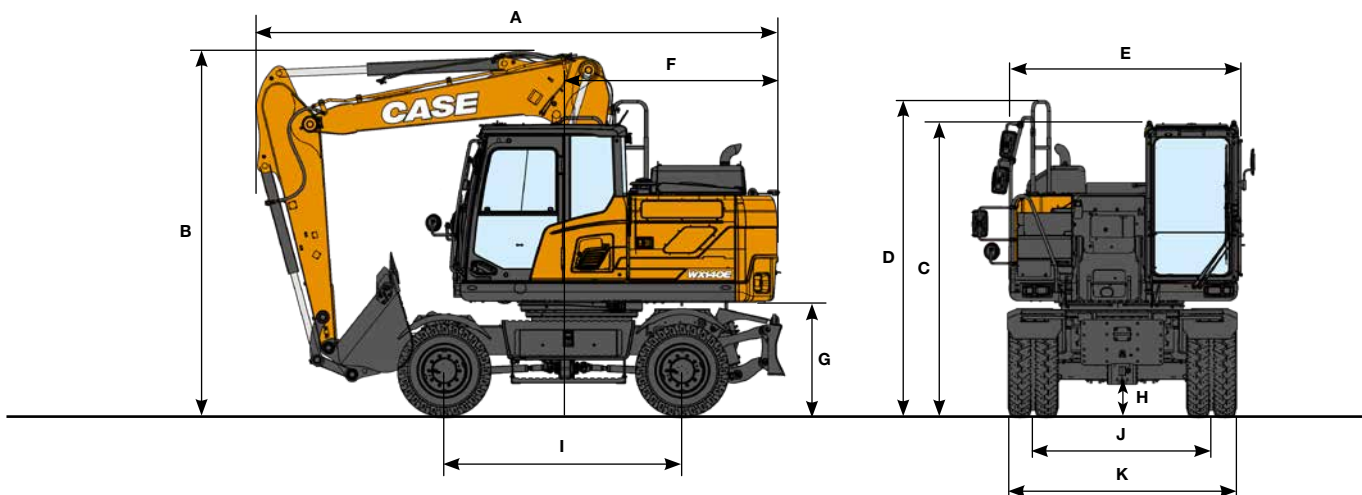

GENERAL DIMENSIONS		Arm 2.45 m	Arm 2.00 m	Arm 2.60 m
A Overall length (with attachment) (traveling/transportation)	mm	5815 / 7800	5845 / 7795	5785 / 7810
B Overall height (to top of boom) (traveling/transportation)	mm	3950 / 2770	3950 / 2720	3950 / 2810
C Cab height	mm	3255	3255	3255
D Overall height (to top of handrail)	mm	3475	3475	3475
E Upper structure overall width	mm	2485	2485	2485
F Swing (rear end) radius	mm	2170	2170	2170
G Clearance height	mm	1260	1260	1260
H Minimum ground clearance	mm	390	390	390
I Wheel base (center to center of wheels)	mm	2600	2600	2600
J Tread	mm	1944	1944	1944
K Undercarriage overall width	mm	2530	2530	2530

WEIGHT

With 2.45 m arm, 0.58 m³ bucket, 10.00×20 twin tires, standard counterweight, operator, lubricant, coolant, full fuel tank.

2-PIECE BOOM	WEIGHT
Rear blade	15860 kg
Front blade and rear stabilizers	16790 kg

Counterweight: 2200 kg





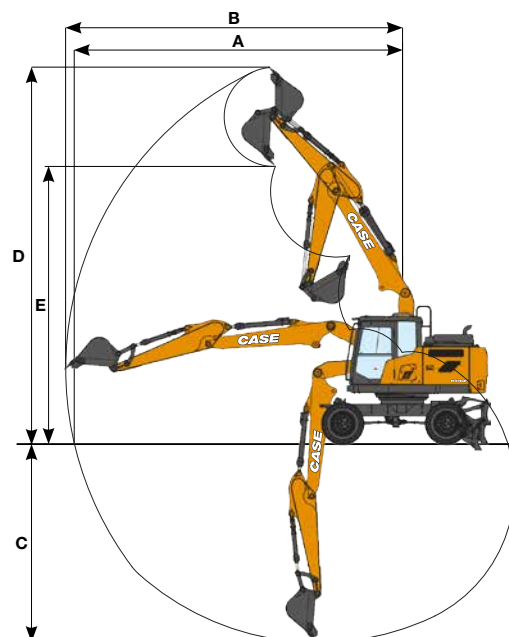



PERFORMANCE DATA		Arm 2.45 m	Arm 2.00 m	Arm 2.60 m
Boom length	mm	4748	4748	4748
A Maximum reach at GRP	mm	8270	7820	8420
B Maximum reach	mm	8490	8050	8630
C Max. digging depth	mm	5000	4550	5150
D Max. digging height	mm	9480	9120	9600
E Max. dumping height	mm	6990	6640	7110
F Min. swing radius	mm	2600	2620	2650

DIGGING FORCE (ISO 6015)		Arm 2.45 m	Arm 2.00 m	Arm 2.60 m
Arm digging force	kN	66	78	64
with Auto power up	kN	72	85	69
Bucket digging force	kN	103	103	103
with Auto power up	kN	112	112	112



LIFTING CAPACITY

WX140E 2-PIECE BOOM

		REACH									
		3.0 m		4.5 m		6.0 m		At max reach		m	
Front	Side										
REAR BLADE DOWN - 2-piece boom 4.748 m, arm 2.0 m, 2200 kg counterweight											
7.5 m				4210*	4020			4410*	4410*	3.69	
6.0 m								3470*	2970	5.37	
4.5 m	5800*	5800*		4630*	3890	3870	2460	3200*	2280	6.26	
3.0 m				5580*	3650	3780	2390	3170	2000	6.71	
1.5 m				5670	3420	3680	2300	3070	1920	6.79	
0 m	4830*	4830*		5540	3310	3620	2240	3220	2010	6.52	
-1.5 m	9500*	6110		5540	3310			3780	2340	5.86	
REAR BLADE UP - 2-piece boom 4.748 m, arm 2.0 m, 2200 kg counterweight											
7.5 m								4410*	4410*	3.69	
6.0 m				4210*	3650			3470*	2690	5.37	
4.5 m	5800*	5800*		4630*	3530	3870	2230	3200*	2060	6.26	
3.0 m				5580*	3290	3780	2160	3170	1810	6.71	
1.5 m				5670	3070	3680	2070	3070	1730	6.79	
0 m	4830*	4830*		5540	2960	3620	2010	3220	1810	6.52	
-1.5 m	9500*	5380		5540	2960			3780	2120	5.86	
REAR BLADE DOWN - 2-piece boom 4.748 m, arm 2.45 m, 2200 kg counterweight											
7.5 m								3030*	3030*	4.46	
6.0 m				3710*	3710*			2500*	2500*	5.92	
4.5 m				4190*	3950	3880*	2490	2320*	2030	6.74	
3.0 m				5190*	3690	3800	2400	2300*	1800	7.15	
1.5 m				5690	3440	3670	2280	2410*	1730	7.23	
0 m	5270*	5270*		5520	3290	3590	2210	2670*	1800	6.98	
-1.5 m	9410*	6000		5480	3250	3580	2200	3220*	2050	6.37	
REAR BLADE UP - 2-piece boom 4.748 m, arm 2.45 m, 2200 kg counterweight											
7.5 m								3030*	3030*	4.46	
6.0 m				3710*	3710*			2500*	2310	5.92	
4.5 m				4190*	3580	3880*	2260	2320*	1830	6.74	
3.0 m				5190*	3330	3800	2160	2300*	1620	7.15	
1.5 m				5690	3080	3670	2060	2410*	1550	7.23	
0 m	5270*	5250		5520	2940	3590	1980	2670*	1610	6.98	
-1.5 m	9410*	5280		5480	2900	3580	1970	3220*	1840	6.37	
FRONT BLADE & REAR STABILIZERS DOWN - 2-piece boom 4.748 m, arm 2.45 m, 2200 kg counterweight											
7.5 m								3040*	3040*	4.46	
6.0 m				3720*	3720*			2500*	2500*	5.92	
4.5 m				4200*	4200*	3880*	3880*	2320*	2320*	6.74	
3.0 m				5190*	5190*	4250*	4070	2310*	2310*	7.15	
1.5 m				6220*	6110	4700*	3950	2410*	2410*	7.23	
0 m	5270*	5270*		6790*	5930	4980*	3860	2680*	2680*	6.98	
-1.5 m	9410*	9410*		6690*	5900	4780*	3860	3230*	3230*	6.37	
FRONT BLADE & REAR STABILIZERS UP - 2-piece boom 4.748 m arm 2.45 m 2200 kg counterweight											
7.5 m								3040*	3040*	4.46	
6.0 m				3720*	3720*			2500*	2500*	5.92	
4.5 m				4200*	4200*	3880*	2860	2320*	2320*	6.74	
3.0 m				5190*	4250	3890	2760	2310*	2090	7.15	
1.5 m				5830	3990	3770	2650	2410*	2020	7.23	
0 m	5270*	5270*		5660	3830	3680	2570	2680*	2100	6.98	
-1.5 m	9410*	7070		5620	3800	3680	2570	3230*	2390	6.37	
REAR BLADE DOWN - 2-piece boom 4.748 m, arm 2.60 m, 2200 kg counterweight											
7.5 m				3340*	3340*			2790*	2790*	4.70	
6.0 m				3560*	3560*	2730*	2520	2330*	2330*	6.10	
4.5 m				4050*	3980	3770*	2510	2170*	1960	6.90	
3.0 m	7450*	6900		5050*	3710	3810	2400	2150*	1750	7.30	
1.5 m				5700	3440	3680	2290	2250*	1680	7.37	
0 m	5350*	5350*		5510	3280	3580	2200	2480*	1740	7.13	
-1.5 m	9050*	5960		5460	3240	3570	2190	2970*	1970	6.53	
3.0 m				5550	3310						
REAR BLADE UP - 2-piece boom 4.748 m, arm 2.60 m, 2200 kg counterweight											
7.5 m				3340*	3340*			2790*	2790*	4.70	
6.0 m				3560*	3560*	2730*	2280	2330*	2210	6.10	
4.5 m				4050*	3610	3770*	2270	2170*	1770	6.90	
3.0 m	7450*	6140		5050*	3350	3810	2170	2150*	1570	7.30	
1.5 m				5700	3090	3680	2060	2250*	1510	7.37	
0 m	5350*	5230		5510	2930	3580	1980	2480*	1560	7.13	
-1.5 m	9050*	5240		5460	2890	3570	1960	2970*	1760	6.53	
3.0 m				5550	2960						

* The above loads (kg) are compliant to the ISO standards and refer to the excavator equipped without bucket. The indicated loads are no more than 87% of hydraulic system lift capacity or 75% of static tipping load. Values marked with an asterisk (*) are limited by the hydraulic lifting capacity.

BUCKETS

WX140E 2-PIECE BOOM

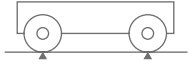

QUICK COUPLED - ON WHEELS

Capacity m ³ (ISO7451 HEAPED)	Width mm	Weight kg	Arm 2.00 m	Arm 2.45 m 2.60 m
GENERAL PURPOSE BUCKETS				
0.21	450	250	○	○
0.31	600	290	○	○
0.41	750	330	○	○
0.52	900	360	○	●
0.58	1000	400	●	▲
0.66	1100	430	▲	■
0.73	1200	450	■	-

Capacity m ³ (ISO7451 HEAPED)	Width mm	Weight kg	Arm 2.00 m	Arm 2.45 m 2.60 m
HEAVY DUTY BUCKETS				
0.21	450	350	○	○
0.31	600	400	○	○
0.42	750	460	○	●
0.45	800	470	○	●
0.52	900	510	●	▲
0.60	1000	550	▲	■
0.67	1100	580	■	-

Capacity m ³ (ISO7451 HEAPED)	Width mm	Weight* kg	Arm 2.00 m	Arm 2.45 m 2.60 m
GRADING BUCKETS				
0.59	1500	440	●	■
0.72	1800	510	■	-

Capacity m ³ (ISO7451 HEAPED)	Width mm	Weight* kg	Arm 2.00 m	Arm 2.45 m 2.60 m
DITCH CLEANING BUCKETS				
0.54	1830	480	●	▲

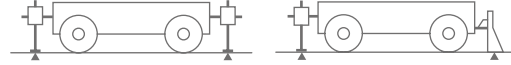

QUICK COUPLED - STABILIZED

Capacity m ³ (ISO7451 HEAPED)	Width mm	Weight kg	Arm 2.00 m	Arm 2.45 m 2.60 m
GENERAL PURPOSE BUCKETS				
0.21	450	250	○	○
0.31	600	290	○	○
0.41	750	330	○	○
0.52	900	360	○	●
0.58	1000	400	●	▲
0.66	1100	430	▲	■
0.73	1200	450	■	■

Capacity m ³ (ISO7451 HEAPED)	Width mm	Weight kg	Arm 2.00 m	Arm 2.45 m 2.60 m
HEAVY DUTY BUCKETS				
0.21	450	350	○	○
0.31	600	400	○	○
0.42	750	460	○	○
0.45	800	470	○	●
0.52	900	510	●	▲
0.60	1000	550	▲	▲
0.67	1100	580	▲	■

Capacity m ³ (ISO7451 HEAPED)	Width mm	Weight* kg	Arm 2.00 m	Arm 2.45 m 2.60 m
GRADING BUCKETS				
0.59	1500	440	●	▲
0.72	1800	510	▲	■
0.80	2000	550	■	-

Capacity m ³ (ISO7451 HEAPED)	Width mm	Weight* kg	Arm 2.00 m	Arm 2.45 m 2.60 m
DITCH CLEANING BUCKETS				
0.54	1830	480	○	●

○ Rated material density up to 2 ton/m³
● Rated material density up to 1.6 ton/m³

▲ Rated material density up to 1.4 ton/m³
■ Rated material density up to 1.2 ton/m³

— Not applicable
* with bolt-on cutting edge

SPECIFICATIONS

WX160E

ENGINE

Model _____ Cummins B4.5
Type _____ Water-cooled, 4-cycle diesel, 4-cylinder in line,
High pressure common rail system (electric control),
turbocharger with air cooled intercooler, DOC+DPF+SCR,
EGR free.
Emissions _____ Stage V
Number of cylinders / Displacement (l) _____ 4 / 4.5
Bore and stroke (mm) _____ 107 x 124
Rated flywheel horse power
ISO 9249 (kW) _____ 127 at 2200 min⁻¹ (rpm)
ISO 14396 (kW) _____ 129 at 2200 min⁻¹ (rpm)
Maximum torque
ISO 14396 (Nm) _____ 780 at 1500 min⁻¹ (rpm)

HYDRAULIC SYSTEM

Main pump _____ Variable displacement piston pump
Max. oil flow (l/min) _____ 260 at 1800 min⁻¹
Working circuit pressure
Boom/Arm/Bucket (MPa) _____ 34.3 - 37.3 with auto power boost
Swing circuit (MPa) _____ 26.5
Travel circuit (MPa) _____ 37.3
Pilot circuit (MPa) _____ 3.4
Boom cylinders
Bore (mm) _____ 110
Stroke (mm) _____ 1090
Boom positioning (2 piece boom only)
Bore (mm) _____ 160
Stroke (mm) _____ 613
Arm cylinder
Bore (mm) _____ 120
Stroke (mm) _____ 1235
Bucket cylinder
Bore (mm) _____ 105
Stroke (mm) _____ 995

SWING

Swing motor _____ Fixed displacement radial piston motor
Maximum swing speed (min⁻¹) _____ 9.3
Swing torque (Nm) _____ 36,200
Brake system _____ Automatic, spring applied
hydraulic released

ELECTRICAL SYSTEM

Voltage (V) _____ 24
Alternator (Amp) _____ 95
Starter (V - kW) _____ 24 - 4.8
Battery _____ 2 X 12 V 100 Ah

STEERING

Type _____ Orbitrol steering system
Minimum turning radius (m) _____ 6.3

AXLES

Type _____ 4 wheel drive with differential, oscillating front axle
with automatic or operator controlled oscillation lock,
fixed rear axle
Brake type _____ Wet multi-disc
Parking brake type _____ Wet multi-disc integrated
in transmission

UNDERCARRIAGE

Transmission _____ 2 speed hydrostatic powershift
Travel motor _____ Variable displacement bent-axis axial
piston motor
High travel speed (Automatic travel speed shifting) (km/h) _____ 35
Low travel speed (km/h) _____ 10
Creep speed (km/h) _____ 3
Drawbar pull (kN) _____ 103
Gradeability _____ 58% (30°)

NOISE

External guaranteed sound level
(EU Directive 2000/14/EC) _____ LwA 99 dB(A)
Operator cab sound pressure level (ISO 6396) _____ LpA 72 dB(A)

CIRCUIT AND COMPONENT CAPACITIES

Fuel tank (l) _____ 250
Hydraulic system (l) _____ 204
Hydraulic tank (l) _____ 122
AdBlue tank (l) _____ 48

DIMENSIONS

WX160E MONO

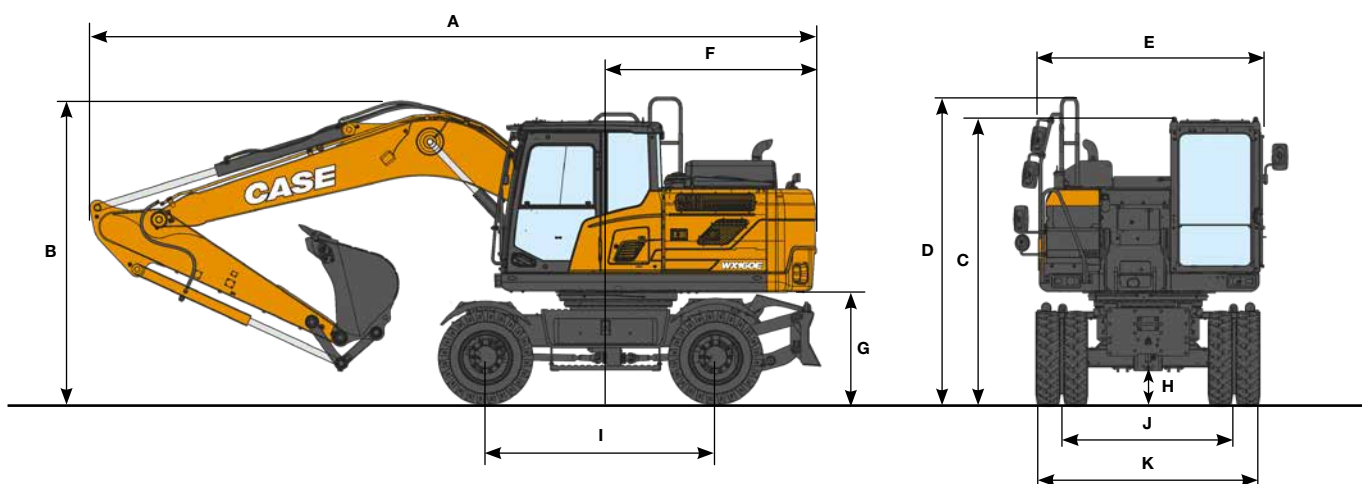

GENERAL DIMENSIONS		Arm 2.45 m	Arm 2.00 m	Arm 2.60 m	Arm 3.10 m
A Overall length (with attachment) (traveling/transportation)	mm	8180 / 8140	8230 / 8190	8065 / 8025	8060 / 8020
B Overall height (to top of boom) (traveling/transportation)	mm	3510 / 2970	3520 / 3095	3790 / 3250	3940 / 3530
C Cab height	mm	3230	3230	3230	3230
D Overall height (to top of handrail)	mm	3450	3450	3450	3450
E Upper structure overall width	mm	2485	2485	2485	2485
F Swing (rear end) radius	mm	2250	2250	2250	2250
G Clearance height under upper structure	mm	1265	1265	1265	1265
H Minimum ground clearance	mm	370	370	370	370
I Wheel base (center to center of wheels)	mm	2600	2600	2600	2600
J Tread	mm	1944 / 2114	1944 / 2114	1944 / 2114	1944 / 2114
K Undercarriage overall width	mm	2530	2530	2530	2530

WEIGHT

With 2.45 m arm, 0.70 m³ bucket, 10.00×20 twin tires, standard counterweight, operator, lubricant, coolant, full fuel tank.

MONO	WEIGHT
Rear blade	17580 kg
Front blade and rear stabilizers	18800 kg

Std counterweight: 2910 kg
Heavy counterweight: 2910 kg + 500 kg

PERFORMANCE DATA		Arm 2.45 m	Arm 2.00 m	Arm 2.60 m	Arm 3.10 m
Boom length	mm	5000	5000	5000	5000
A Maximum reach at GRP	mm	8610	8140	8660	9090
B Maximum reach	mm	8820	8360	8865	9285
C Max. digging depth	mm	5610	5160	5760	6260
D Max. digging height	mm	9010	8640	8810	8920
E Max. dumping height	mm	6360	6030	6210	6350
F Min. swing radius	mm	3170	3480	3450	3500

DIGGING FORCE (ISO 6015)		Arm 2.45 m	Arm 2.00 m	Arm 2.60 m	Arm 3.10 m
Arm digging force	kN	77	97	76	67
with Auto power up	kN	84	106	83	73
Bucket digging force	kN	115	115	115	115
with Auto power up	kN	125	125	126	126

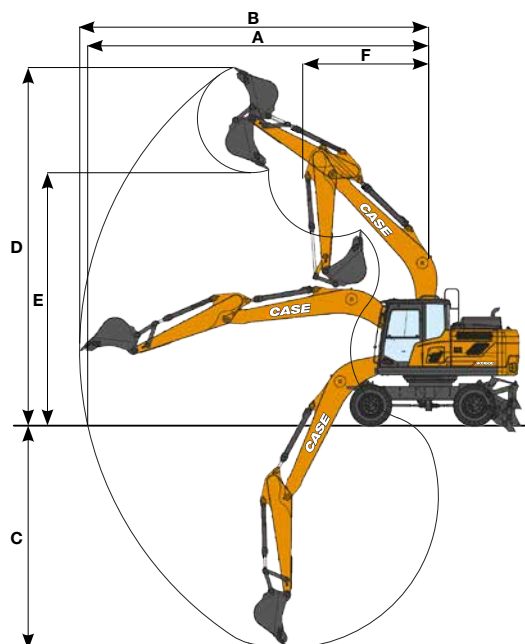

LIFTING CAPACITY

WX160E MONO

REACH												
Front	1.5 m		3.0 m		4.5 m		6.0 m		7.5 m		At max reach	m
Side												

REAR BLADE DOWN - Mono boom 5.0 m, arm 2.00 m, 2910 kg counterweight

7.5 m													
6.0 m					4560*	4560*					4580*	3240	5.60
4.5 m					5180*	4470	4430	2860			3920	2530	6.47
3.0 m					6290*	4170	4320	2760			3480	2230	6.90
1.5 m					6430	3920	4190	2640			3360	2130	6.99
0 m					6290	3800	4120	2580			3510	2210	6.73
-1.5 m			9960*	7040	6290	3800	4130	2590			4040	2540	6.10
-3.0 m			7850*	7220	5540*	3920					4790*	3470	4.94

REAR BLADE UP - Mono boom 5.0 m, arm 2.00 m, 2910 kg counterweight

7.5 m													
6.0 m					4560*	4210					4580*	2940	5.60
4.5 m					5180*	4040	4430	2590			3920	2290	6.47
3.0 m					6290*	3760	4320	2490			3480	2010	6.90
1.5 m					6430	3510	4190	2380			3360	1920	6.99
0 m					6290	3390	4120	2310			3510	1990	6.73
-1.5 m			9960*	6180	6290	3390	4130	2320			4040	2280	6.10
-3.0 m			7850*	6360	5540*	3510					4790*	3120	4.94

REAR BLADE DOWN - Mono boom 5.0 m, arm 2.45 m, 2910 kg counterweight

7.5 m											3180*	3180*	4.77
6.0 m							3550*	2940			2750*	2750*	6.16
4.5 m					4730*	4540	4240*	2900			2630*	2260	6.96
3.0 m					5890*	4240	4350	2780			2660*	2020	7.36
1.5 m					6470	3960	4200	2650			2830*	1940	7.44
0 m			5870*	5870*	6290	3800	4110	2570			3170	2000	7.21
-1.5 m	5810*	5810*	10160*	6950	6250	3770	4090	2550			3570	2250	6.62
-3.0 m	10280*	10280*	8790*	7110	6160*	3840					4540*	2900	5.57

REAR BLADE DOWN (WIDE AXLES) - Mono boom 5.0 m, arm 2.45 m, 2910 kg counterweight

7.5 m											3180*	3180*	4.77
6.0 m							3550*	3280			2750*	2750*	6.16
4.5 m					4730*	4730*	4240*	3250			2630*	2540	6.96
3.0 m					5890*	4790	4360	3120			2660*	2270	7.36
1.5 m					6490	4490	4210	2990			2830*	2190	7.44
0 m			5870*	5870*	6310	4330	4120	2900			3180	2260	7.21
-1.5 m	5810*	5810*	10160*	8100	6270	4290	4100	2880			3580	2540	6.62
-3.0 m	10280*	10280*	8790*	8260	*6160*	4370					4540*	3270	5.57

REAR BLADE UP - Mono boom 5.0 m, arm 2.45 m, 2910 kg counterweight

7.5 m											3180*	3180*	4.77
6.0 m							3550*	2670			2750*	2540	6.16
4.5 m					4730*	4120	4240*	2630			2630*	2050	6.96
3.0 m					5890*	3820	4350	2510			2660*	1820	7.36
1.5 m					6470	3550	4200	2390			2830*	1740	7.44
0 m			5870*	5870*	6290	3390	4110	2300			3170	1790	7.21
-1.5 m	5810*	5810*	10160*	6100	6250	3360	4090	2280			3570	2020	6.62
-3.0 m	10280*	10280*	8790*	6250	6160*	3430					4540*	2600	5.57

REAR BLADE UP (WIDE AXLES) - Mono boom 5.0 m, arm 2.45 m, 2910 kg counterweight

7.5 m											3180*	3180*	4.77
6.0 m							3550*	2930			2750*	2750*	6.16
4.5 m					4730*	4520	4240*	2890			2630*	2250	6.96
3.0 m					5890*	4220	4360	2770			2660*	2010	7.36
1.5 m					6490	3940	4210	2640			2830*	1930	7.44
0 m			5870*	5870*	6310	3780	4120	2550			3180	1990	7.21
-1.5 m	5810*	5810*	10160*	6910	6270	3750	4100	2530			3580	2240	6.62
-3.0 m	10280*	10280*	8790*	7070	6160*	3830					4540*	2880	5.57

* The above loads (kg) are compliant to the ISO standards and refer to the excavator equipped without bucket. The indicated loads are no more than 87% of hydraulic system lift capacity or 75% of static tipping load. Values marked with an asterisk (*) are limited by the hydraulic lifting capacity.

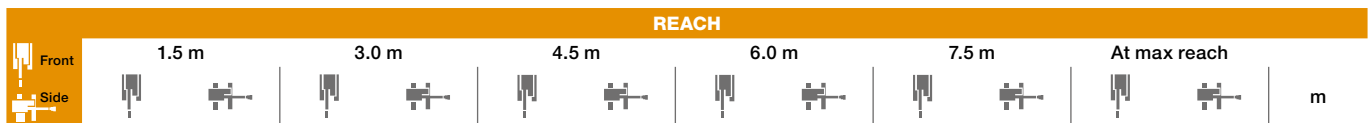

FRONT BLADE & REAR STABILIZERS DOWN - Mono boom 5.0 m, arm 2.45 m, 2910 kg counterweight

7.5 m										3180*	3180*	4.77
6.0 m										2750*	2750*	6.16
4.5 m										2630*	2630*	6.96
3.0 m										2660*	2660*	7.36
1.5 m										2830*	2830*	7.44
0 m										3190*	3190*	7.21
-1.5 m	5810*	5810*								3900*	3850	6.62
-3.0 m	10280*	10280*								4540*	4540*	5.57

FRONT BLADE & REAR STABILIZERS UP - Mono boom 5.0 m, arm 2.45 m, 2910 kg counterweight

7.5 m										3180*	3180*	4.77
6.0 m										2750*	2750*	6.16
4.5 m										2630*	2600	6.96
3.0 m										2660*	2330	7.36
1.5 m										2830*	2250	7.44
0 m										3190*	2320	7.21
-1.5 m	5810*	5810*								3620	2600	6.62
-3.0 m	10280*	10280*								4540*	3350	5.57

REAR BLADE DOWN - Mono boom 5.0 m, arm 2.60 m, 2910 kg counterweight

7.5 m										3360*	3360*	4.96
6.0 m										2950*	2680	6.31
4.5 m										2830*	2180	7.09
3.0 m										2880*	1940	7.49
1.5 m										2960	1860	7.56
0 m										3060	1920	7.33
-1.5 m	5590*	5590*								3430	2140	6.76
-3.0 m	9860*	9860*								4400	2730	5.74

REAR BLADE UP - Mono boom 5.0 m, arm 2.60 m, 2910 kg counterweight

7.5 m										3360*	3360*	4.96
6.0 m										2950*	2430	6.31
4.5 m										2830*	1960	7.09
3.0 m										2880*	1750	7.49
1.5 m										2960	1670	7.56
0 m										3060	1720	7.33
-1.5 m	5590*	5590*								3430	1920	6.76
-3.0 m	9860*	9860*								4400	2450	5.74

REAR BLADE DOWN - Mono boom 5.0 m, arm 3.10 m, 2910 kg counterweight

7.5 m										2680*	2680*	5.62
6.0 m										2420*	2410	6.83
4.5 m										2340*	2000	7.56
3.0 m										2390*	1800	7.93
1.5 m										2540*	1730	8.00
0 m										2820	1760	7.78
-1.5 m	5170*	5170*								3100	1940	7.25
-3.0 m	8430*	8430*								3800	2370	6.31
-4.5 m										4240*	3670	4.72

REAR BLADE UP - Mono boom 5.0 m, arm 3.10 m, 2910 kg counterweight

7.5 m										2680*	2680*	5.62
6.0 m										2420*	2180	6.83
4.5 m										2340*	1810	7.56
3.0 m										2390*	1620	7.93
1.5 m										2540*	1550	8.00
0 m										2820	1580	7.78
-1.5 m	5170*	5170*								3100	1730	7.25
-3.0 m	8430*	8430*								3800	2120	6.31
-4.5 m										4240*	3280	4.72

* The above loads (kg) are compliant to the ISO standards and refer to the excavator equipped without bucket. The indicated loads are no more than 87% of hydraulic system lift capacity or 75% of static tipping load. Values marked with an asterisk (*) are limited by the hydraulic lifting capacity.

LIFTING CAPACITY

WX160E MONO

		REACH											
Front Side	1.5 m		3.0 m		4.5 m		6.0 m		7.5 m		At max reach		m
	Front	Side	Front	Side	Front	Side	Front	Side	Front	Side	Front	Side	

REAR BLADE DOWN - Mono boom 5.0 m, arm 2.0 m, 3410 kg counterweight

7.5 m													
6.0 m					4560*	4560*					4580*	3480	5.60
4.5 m					5180*	4790	4560*	3090			4180	2740	6.47
3.0 m					6290*	4500	4600	2990			3720	2420	6.90
1.5 m					6860	4250	4480	2870			3600	2320	6.99
0 m					6720	4130	4410	2810			3750	2410	6.73
-1.5 m			9960*	7620	6720	4130	4420	2820			4320	2760	6.10
-3.0 m			7850*	7810	5540*	4250					4790*	3760	4.94

REAR BLADE UP - Mono boom 5.0 m, arm 2.0 m, 3410 kg counterweight

7.5 m													
6.0 m					4560*	4520					4580*	3170	5.60
4.5 m					5180*	4350	4560*	2810			4180	2490	6.47
3.0 m					6290*	4070	4600	2710			3720	2190	6.90
1.5 m					6860	3820	4480	2600			3600	2100	6.99
0 m					6720	3710	4410	2530			3750	2180	6.73
-1.5 m			9960*	6720	6720	3700	4420	2540			4320	2490	6.10
-3.0 m			7850*	6900	5540*	3820					4790*	3390	4.94

REAR BLADE DOWN - Mono boom 5.0 m, arm 2.45 m, 3410 kg counterweight

7.5 m											3180*	3180*	4.77
6.0 m							3550*	3170			2750*	2750*	6.16
4.5 m					4730*	4730*	4240*	3130			2630*	2450	6.96
3.0 m					5890*	4570	4630	3010			2660*	2200	7.36
1.5 m					6910	4290	4490	2880			2830*	2120	7.44
0 m					6720	4130	4400	2790			3190*	2180	7.21
-1.5 m	5810*	5810*	10160*	7530	6690	4090	4370	2770			3830	2450	6.62
-3.0 m	10280*	10280*	8790*	7690	6160*	4170					4540*	3150	5.57

REAR BLADE UP - Mono boom 5.0 m, arm 2.45 m, 3410 kg counterweight

7.5 m											3180*	3180*	4.77
6.0 m							3550*	2890			2750*	2750*	6.16
4.5 m					4730*	4430	4240*	2850			2630*	2230	6.96
3.0 m					5890*	4130	4630	2730			2660*	1990	7.36
1.5 m					6910	3860	4490	2610			2830*	1910	7.44
0 m					6720	3700	4400	2520			3190*	1970	7.21
-1.5 m	5810*	5810*	10160*	6640	6690	3670	4370	2500			3830	2210	6.62
-3.0 m	10280*	10280*	8790*	6790	6160*	3740					4540*	2840	5.57

* The above loads (kg) are compliant to the ISO standards and refer to the excavator equipped without bucket. The indicated loads are no more than 87% of hydraulic system lift capacity or 75% of static tipping load. Values marked with an asterisk (*) are limited by the hydraulic lifting capacity.



REAR BLADE DOWN - Mono boom 5.0 m, arm 2.60 m, 3410 kg counterweight

7.5 m										3360*	3360*	4.96
6.0 m										2950*	2900	6.31
4.5 m				4540*	4540*					4110*	3120	7.09
3.0 m				5700*	4560					4580*	2990	7.49
1.5 m				6830*	4260					4470	2850	7.56
0 m			5970*	5970*	6680	4090				4360	2760	7.33
-1.5 m	5590*	5590*	9940*	7440	6630	4040				3220	2060	6.76
-3.0 m	9860*	9860*	9010*	7590	6270*	4110				3680	2340	5.74
										4490*	2980	

REAR BLADE UP - Mono boom 5.0 m, arm 2.60 m, 3410 kg counterweight

7.5 m										3360*	3360*	4.96
6.0 m										2950*	2640	6.31
4.5 m				4540*	4430					4110*	2840	7.09
3.0 m				5700*	4120					4580*	2710	7.49
1.5 m				6830*	3830					4470	2580	7.56
0 m			5970*	5970*	6680	3660				4360	2480	7.33
-1.5 m	5590*	5590*	9940*	6550	6630	3620				3220	1860	6.76
-3.0 m	9860*	9860*	9010*	6700	6270*	3680				3680	2110	5.74
										4490*	2680	

REAR BLADE DOWN - Mono boom 5.0 m, arm 3.10 m, 3410 kg counterweight

7.5 m										2680*	2680*	5.62
6.0 m										3540*	3260	6.83
4.5 m										3780*	3190	7.56
3.0 m			7570*	7570*	5230*	4670				2570*	2200	7.93
1.5 m					6470*	4330				4300*	3050	8.00
0 m			6640*	6640*	6700	4100				3320	2160	7.78
-1.5 m	5170*	5170*	9310*	7350	6600	4010				3240	2090	7.25
-3.0 m	8430*	8430*	9800*	7460	6640	4050				3180	2030	6.31
-4.5 m			7000*	7000*	4610*	4230				2840*	1930	4.72
										3330	2120	

REAR BLADE UP - Mono boom 5.0 m, arm 3.10 m, 3410 kg counterweight

7.5 m										2680*	2680*	5.62
6.0 m										3540*	2980	6.83
4.5 m										3780*	2910	7.56
3.0 m			7570*	7570*	5230*	4230				2570*	2000	7.93
1.5 m					6470*	3900				4300*	2770	8.00
0 m			6640*	6500	6700	3670				3320	1950	7.78
-1.5 m	5170*	5170*	9310*	6460	6600	3590				3240	1880	7.25
-3.0 m	8430*	8430*	9800*	6570	6640	3620				3180	1830	6.31
-4.5 m			7000*	6840	4610*	3800				2840*	1740	4.72
										3330	1910	

* The above loads (kg) are compliant to the ISO standards and refer to the excavator equipped without bucket. The indicated loads are no more than 87% of hydraulic system lift capacity or 75% of static tipping load. Values marked with an asterisk (*) are limited by the hydraulic lifting capacity.

BUCKETS

WX160E MONO

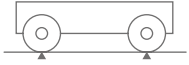

QUICK COUPLED - ON WHEELS

Capacity m ³ (ISO7451 HEAPED)	Width mm	Weight kg	Arm 2.00 m	Arm 2.45 m 2.60 m	Arm 3.10 m
GENERAL PURPOSE BUCKETS					
0.24	450	350	○	○	○
0.36	600	390	○	○	●
0.50	750	440	○	●	■
0.62	900	480	●	■	-
0.70	1000	500	▲	■	-
0.78	1100	540	■	-	-

Capacity m ³ (ISO7451 HEAPED)	Width mm	Weight kg	Arm 2.00 m	Arm 2.45 m 2.60 m	Arm 3.10 m
HEAVY DUTY BUCKETS					
0.26	450	420	○	○	○
0.38	600	480	○	○	●
0.51	750	550	●	●	■
0.65	900	620	▲	■	-
0.70	1000	660	■	-	-

Capacity m ³ (ISO7451 HEAPED)	Width mm	Weight* kg	Arm 2.00 m	Arm 2.45 m 2.60 m	Arm 3.10 m
GRADING BUCKETS					
0.59	1500	440	●	▲	■
0.72	1800	510	▲	■	-

Capacity m ³ (ISO7451 HEAPED)	Width mm	Weight* kg	Arm 2.00 m	Arm 2.45 m 2.60 m	Arm 3.10 m
DITCH CLEANING BUCKETS					
0.86	1830	630	■	-	-

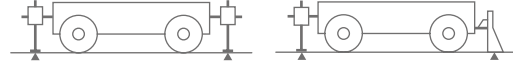

QUICK COUPLED - STABILIZED

Capacity m ³ (ISO7451 HEAPED)	Width mm	Weight kg	Arm 2.00 m	Arm 2.45 m 2.60 m	Arm 3.10 m
GENERAL PURPOSE BUCKETS					
0.24	450	350	○	○	○
0.36	600	390	○	○	●
0.50	750	440	○	●	■
0.62	900	480	●	▲	■
0.70	1000	500	▲	■	-
0.78	1100	540	■	■	-
0.87	1200	570	■	-	-

Capacity m ³ (ISO7451 HEAPED)	Width mm	Weight kg	Arm 2.00 m	Arm 2.45 m 2.60 m	Arm 3.10 m
HEAVY DUTY BUCKETS					
0.26	450	420	○	○	○
0.38	600	480	○	○	●
0.51	750	550	○	●	▲
0.65	900	620	●	▲	■
0.70	1000	660	▲	■	-
0.75	1050	680	■	-	-

Capacity m ³ (ISO7451 HEAPED)	Width mm	Weight* kg	Arm 2.00 m	Arm 2.45 m 2.60 m	Arm 3.10 m
GRADING BUCKETS					
0.59	1500	440	●	●	▲
0.72	1800	510	●	▲	■

Capacity m ³ (ISO7451 HEAPED)	Width mm	Weight* kg	Arm 2.00 m	Arm 2.45 m 2.60 m	Arm 3.10 m
DITCH CLEANING BUCKETS					
0.86	1830	630	■	■	-

○ Rated material density up to 2 ton/m³
● Rated material density up to 1.6 ton/m³

▲ Rated material density up to 1.4 ton/m³
■ Rated material density up to 1.2 ton/m³

— Not applicable
* with bolt-on cutting edge

BUCKETS

WX160E MONO (HEAVY COUNTERWEIGHT)

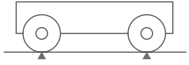

QUICK COUPLED - ON WHEELS

Capacity m ³ (ISO7451 HEAPED)	Width mm	Weight kg	Arm 2.00 m	Arm 2.45 m 2.60 m	Arm 3.10 m
GENERAL PURPOSE BUCKETS					
0.24	450	350	○	○	○
0.36	600	390	○	○	○
0.50	750	440	○	○	●
0.62	900	480	○	●	▲
0.70	1000	500	●	▲	■
0.78	1100	540	▲	■	-
0.87	1200	570	■	-	-
HEAVY DUTY BUCKETS					
0.26	450	420	○	○	○
0.38	600	480	○	○	●
0.51	750	550	○	●	▲
0.65	900	620	●	▲	■
0.70	1000	660	▲	■	-
0.75	1050	680	■	-	-
GRADING BUCKETS					
0.59	1500	440	○	●	■
0.72	1800	510	●	■	-
0.85	2100	570	■	-	-
DITCH CLEANING BUCKETS					
0.86	1830	630	■	■	-

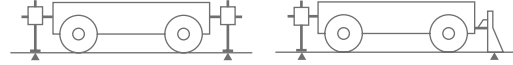

QUICK COUPLED - STABILIZED

Capacity m ³ (ISO7451 HEAPED)	Width mm	Weight kg	Arm 2.00m	Arm 2.45 m 2.60 m	Arm 3.10 m
GENERAL PURPOSE BUCKETS					
0.24	450	350	○	○	○
0.36	600	390	○	○	○
0.50	750	440	○	○	●
0.62	900	480	○	●	▲
0.70	1000	500	●	▲	■
0.78	1100	540	▲	▲	■
0.87	1200	570	▲	■	-
HEAVY DUTY BUCKETS					
0.26	450	420	○	○	○
0.38	600	480	○	○	●
0.51	750	550	○	●	▲
0.65	900	620	●	●	■
0.70	1000	660	●	▲	■
0.75	1050	680	▲	■	-
0.78	1100	700	■	-	-
GRADING BUCKETS					
0.59	1500	440	○	●	▲
0.72	1800	510	●	▲	■
0.85	2100	570	▲	■	-
DITCH CLEANING BUCKETS					
0.86	1830	630	▲	■	-

○ Rated material density up to 2 ton/m³
● Rated material density up to 1.6 ton/m³

▲ Rated material density up to 1.4 ton/m³
■ Rated material density up to 1.2 ton/m³

— Not applicable
* with bolt-on cutting edge

DIMENSIONS

WX160E 2-PIECE BOOM

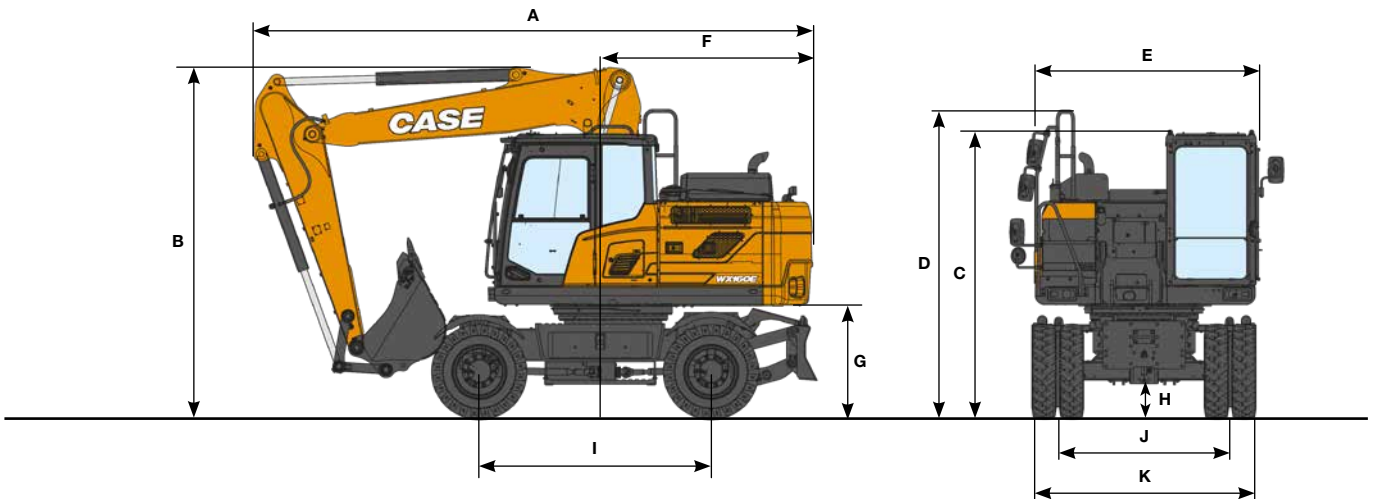

GENERAL DIMENSIONS		Arm 2.45 m	Arm 2.00 m	Arm 2.60 m
A Overall length (with attachment) (traveling/transportation)	mm	6340 / 8345	6375 / 8390	6280 / 8320
B Overall height (to top of boom) (traveling/transportation)	mm	3930 / 2950	3930 / 2990	3930 / 3165
C Cab height	mm	3230	3230	3230
D Overall height (to top of handrail)	mm	3450	3450	3450
E Upper structure overall width	mm	2485	2485	2485
F Swing (rear end) radius	mm	2250	2250	2250
G Clearance height	mm	1265	1265	1265
H Minimum ground clearance	mm	370	370	370
I Wheel base (center to center of wheels)	mm	2600	2600	2600
J Tread	mm	1944 / 2114	1944 / 2114	1944 / 2114
K Undercarriage overall width	mm	2530	2530	2530

WEIGHT

With 2.45 m arm, 0.70 m³ bucket, 10.00×20 twin tires, standard counterweight, operator, lubricant, coolant, full fuel tank.

2-PIECE BOOM	WEIGHT
Rear blade	18390 kg
Front blade and rear stabilizers	19610 kg

Counterweight: 3410 kg





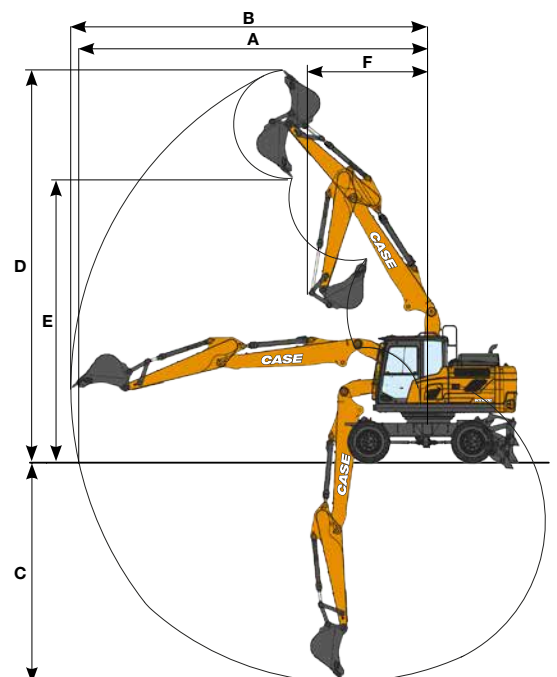





PERFORMANCE DATA		Arm 2.45 m	Arm 2.00 m	Arm 2.60 m
Boom length	mm	5097	5097	5097
A Maximum reach at GRP	mm	8790	8310	8860
B Maximum reach	mm	8990	8530	9060
C Max. digging depth	mm	5540	5080	5660
D Max. digging height	mm	9870	9450	9770
E Max. dumping height	mm	7140	6740	7070
F Min. swing radius	mm	3030	3370	3500

DIGGING FORCE (ISO 6015)		Arm 2.45 m	Arm 2.00 m	Arm 2.60 m
Arm digging force	kN	77	97	76
with Auto power up	kN	84	106	83
Bucket digging force	kN	115	115	115
with Auto power up	kN	125	125	126



LIFTING CAPACITY

WX160E 2-PIECE BOOM

		REACH									
Front Side	3.0 m		4.5 m		6.0 m		7.5 m		At max reach		m
											

REAR BLADE DOWN - 2-piece boom 5.097 m, arm 2.0 m, 3410 kg counterweight

7.5 m										4660*	4660*	4.30
6.0 m			4250*	4250*						4310*	3280	5.81
4.5 m			4880*	4790	4290*	3080				4010	2600	6.65
3.0 m			6000*	4470	4610	2970				3590	2310	7.07
1.5 m			6840	4200	4470	2840				3470	2220	7.15
0 m			6710	4080	4400	2770				3620	2310	6.91
-1.5 m	9910*	7560	6710	4080	4410	2780				4140	2630	6.29
-3.0 m												

REAR BLADE UP - 2-piece boom 5.097 m, arm 2.0 m, 3410 kg counterweight

7.5 m										4660*	4660*	4.30
6.0 m			4250*	4250*						4310*	2980	5.81
4.5 m			4880*	4340	4290*	2800				4010	2360	6.65
3.0 m			6000*	4030	4610	2680				3590	2090	7.07
1.5 m			6840	3760	4470	2560				3470	2000	7.15
0 m			6710	3650	4400	2490				3620	2080	6.91
-1.5 m	9910*	6660	6710	3650	4410	2500				4140	2370	6.29
-3.0 m												

REAR BLADE DOWN - 2-piece boom 5.097 m, arm 2.45 m, 3410 kg counterweight

7.5 m			3940*	3940*						3260*	3260*	5.04
6.0 m			3790*	3790*	3850*	3180				2790*	2790*	6.37
4.5 m			4450*	4450*	3990*	3130				2620*	2330	7.14
3.0 m			5600*	4540	4460*	2990	2960*	2120		2600*	2100	7.54
1.5 m			6720*	4240	4490	2850	3240	2070		2720*	2030	7.61
0 m			6710	4080	4390	2760				2980*	2090	7.38
-1.5 m	8830*	7460	6670	4050	4360	2740				3520*	2340	6.81
-3.0 m			6400*	4130								

REAR BLADE DOWN (WIDE AXLES) - 2-piece boom 5.097 m arm 2.45 m, 3410 kg counterweight

7.5 m			3940*	3940*						3260*	3260*	5.04
6.0 m			3790*	3790*	3850*	3540				2790*	2790*	6.37
4.5 m			4450*	4450*	3990*	3490				2620*	2610	7.14
3.0 m			5600*	5120	4460*	3350	2960*	2380		2600*	2360	7.54
1.5 m			6720*	4800*	4500	3210	3250	2330		2720*	2280	7.61
0 m			6720	4630	4400	3120				2980*	2360	7.38
-1.5 m	8830*	8680	6690	4600	4370	3100				3520*	2640	6.81
-3.0 m			6400*	4690								

REAR BLADE UP - 2-piece boom 5.097 m, arm 2.45 m, 3410 kg counterweight

7.5 m			3940*	3940*						3260*	3260*	5.04
6.0 m			3790*	3790*	3850*	2890				2790*	2590	6.37
4.5 m			4450*	4420	3990*	2840				2620*	2110	7.14
3.0 m			5600*	4100	4460*	2710	2960*	1910		2600*	1890	7.54
1.5 m			6720*	3800	4490	2570	3240	1870		2720*	1820	7.61
0 m			6710	3640	4390	2480				2980*	1880	7.38
-1.5 m	8830*	6560	6670	3610	4360	2460				3520*	2100	6.81
-3.0 m			6400*	3700								











REAR BLADE UP (WIDE AXLES) - 2-piece boom 5.097 m, arm 2.45 m, 3410 kg counterweight

7.5 m			3940*	3940*						3260*	3260*	5.04
6.0 m			3790*	3790*	3850*	3170				2790*	2790*	6.37
4.5 m			4450*	4450*	3990*	3110				2620*	2330	7.14
3.0 m			5600*	4520	4460*	2980	2960*	2110		2600*	2090	7.54
1.5 m			6720*	4220	4500	2840	3250	2060		2720*	2020	7.61
0 m			6720	4060	4400	2750				2980*	2080	7.38
-1.5 m	8830*	7420	6690	4030	4370	2730				3520*	2330	6.81
-3.0 m			6400*	4110								

* The above loads (kg) are compliant to the ISO standards and refer to the excavator equipped without bucket. The indicated loads are no more than 87% of hydraulic system lift capacity or 75% of static tipping load. Values marked with an asterisk (*) are limited by the hydraulic lifting capacity.

LIFTING CAPACITY

WX160E 2-PIECE BOOM

		REACH									
Front Side	3.0 m		4.5 m		6.0 m		7.5 m		At max reach		m
											
FRONT BLADE & REAR STABILIZERS DOWN - 2-piece boom 5.097 m, arm 2.45 m, 3410 kg counterweight											
7.5 m			3940*	3940*					3260*	3260*	5.04
6.0 m			3790*	3790*	3850*	3850*			2790*	2790*	6.37
4.5 m			4450*	4450*	3990*	3990*			2620*	2620*	7.14
3.0 m			5600*	5600*	4460*	4460*	2960*	2960*	2600*	2600*	7.54
1.5 m			6720*	6720*	4990*	4810	3810	3480	2720*	2720*	7.61
0 m			7310*	7220	5340*	4710			2980*	2980*	7.38
-1.5 m	8830*	8830*	7260*	7180	5300*	4690			3520*	3520*	6.81
-3.0 m			6400*	6400*							
FRONT BLADE & REAR STABILIZERS UP - 2-piece boom 5.097 m, arm 2.45 m, 3410 kg counterweight											
7.5 m			3940*	3940*					3260*	3260*	5.04
6.0 m			3790*	3790*	3850*	3600			2790*	2790*	6.37
4.5 m			4450*	4450*	3990*	3550			2620*	2620*	7.14
3.0 m			5600*	5190	4460*	3420	2960*	2430	2600*	2410	7.54
1.5 m			6720*	4870	4540	3280	3280	2390	2720*	2330	7.61
0 m			6790	4710	4440	3180			2980*	2410	7.38
-1.5 m	8830*	8720	6750*	4680	4420	3160			3520*	2690	6.81
-3.0 m			6400*	4770							
REAR BLADE DOWN - 2-piece boom 5.097 m, arm 2.60 m, 3410 kg counterweight											
7.5 m			3710*	3710*					3450*	3450*	5.23
6.0 m			3610*	3610*	3670*	3180			2990*	2730	6.52
4.5 m			4270*	4270*	3850*	3110			2830*	2240	7.28
3.0 m			5420*	4540	4340*	2970	3270	2100	2830*	2020	7.67
1.5 m			6570*	4210	4460	2830	3210	2040	2960*	1950	7.74
0 m			6660	4030	4350	2720	3180	2010	3170	2000	7.52
-1.5 m	8610*	7370	6620	3990	4320	2690			3530	2230	6.96
-3.0 m			6480*	4070							
REAR BLADE UP - 2-piece boom 5.097 m, arm 2.60 m, 3410 kg counterweight											
7.5 m			3710*	3710*					3450*	3450*	5.23
6.0 m			3610*	3610*	3670*	2890			2990*	2470	6.52
4.5 m			4270*	4270*	3850*	2830			2830*	2030	7.28
3.0 m			5420*	4090	4340*	2690	3270	1890	2830*	1820	7.67
1.5 m			6570*	3780	4460	2540	3210	1840	2960*	1750	7.74
0 m			6660	3600	4350	2440	3180	1800	3170	1800	7.52
-1.5 m	8610*	6470	6620	3560	4320	2420			3530	2010	6.96
-3.0 m			6480*	3630							

* The above loads (kg) are compliant to the ISO standards and refer to the excavator equipped without bucket. The indicated loads are no more than 87% of hydraulic system lift capacity or 75% of static tipping load. Values marked with an asterisk (*) are limited by the hydraulic lifting capacity.

BUCKETS

WX160E 2-PIECE BOOM



QUICK COUPLED - ON WHEELS

Capacity m ³ (ISO7451 HEAPED)	Width mm	Weight kg	Arm 2.00 m	Arm 2.45 m 2.60 m
GENERAL PURPOSE BUCKETS				
0.24	450	350	○	○
0.36	600	390	○	○
0.50	750	440	○	●
0.62	900	480	●	▲
0.70	1000	500	●	■
0.78	1100	540	■	-
0.87	1200	570	■	-

Capacity m ³ (ISO7451 HEAPED)	Width mm	Weight kg	Arm 2.00 m	Arm 2.45 m 2.60 m
HEAVY DUTY BUCKETS				
0.26	450	420	○	○
0.38	600	480	○	○
0.51	750	550	○	●
0.65	900	620	●	■
0.70	1000	660	■	■
0.75	1050	680	■	-

Capacity m ³ (ISO7451 HEAPED)	Width mm	Weight* kg	Arm 2.00 m	Arm 2.45 m 2.60 m
GRADING BUCKETS				
0.59	1500	440	●	▲
0.72	1800	510	▲	■
0.85	2100	570	■	-

Capacity m ³ (ISO7451 HEAPED)	Width mm	Weight* kg	Arm 2.00 m	Arm 2.45 m 2.60 m
DITCH CLEANING BUCKETS				
0.86	1830	630	■	-

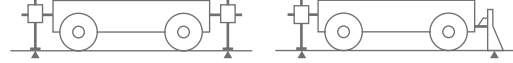

QUICK COUPLED - STABILIZED

Capacity m ³ (ISO7451 HEAPED)	Width mm	Weight kg	Arm 2.00 m	Arm 2.45 m 2.60 m
GENERAL PURPOSE BUCKETS				
0.24	450	350	○	○
0.36	600	390	○	○
0.50	750	440	○	●
0.62	900	480	●	▲
0.70	1000	500	●	▲
0.78	1100	540	▲	■
0.87	1200	570	■	-

Capacity m ³ (ISO7451 HEAPED)	Width mm	Weight kg	Arm 2.00 m	Arm 2.45 m 2.60 m
HEAVY DUTY BUCKETS				
0.26	450	420	○	○
0.38	600	480	○	○
0.51	750	550	○	●
0.65	900	620	●	▲
0.70	1000	660	▲	■
0.75	1050	680	■	■
0.78	1050	700	■	-

Capacity m ³ (ISO7451 HEAPED)	Width mm	Weight* kg	Arm 2.00 m	Arm 2.45 m 2.60 m
GRADING BUCKETS				
0.59	1500	440	●	●
0.72	1800	510	●	▲
0.85	2100	570	▲	■

Capacity m ³ (ISO7451 HEAPED)	Width mm	Weight* kg	Arm 2.00 m	Arm 2.45 m 2.60 m
DITCH CLEANING BUCKETS				
0.54	1830	630	■	■

○ Rated material density up to 2 ton/m³
● Rated material density up to 1.6 ton/m³

▲ Rated material density up to 1.4 ton/m³
■ Rated material density up to 1.2 ton/m³

— Not applicable
* with bolt-on cutting edge

BUILDING A STRONG CASE.

Since 1842, at CASE Construction Equipment we have lived by an unwavering commitment to build practical, intuitive solutions that deliver both efficiency and productivity.

We continually strive to make it easier for our customers to implement emerging technologies and new compliance mandates.

Today, our global scale combined with our local expertise enables us to keep customers' real-world challenges at the center of our product development.

The vast CASE dealers' network is always ready to support and protect your investment and exceed your expectations, while also providing you with the ultimate ownership experience.

Our goal is to build both stronger machines-and stronger communities. At the end of the day, we do what's right for our customers and our communities so that they can count on CASE.

CNH Industrial
Deutschland GmbH
Case Baumaschinen
Benzstr. 1-3 - D-74076 Heilbronn
DEUTSCHLAND

CNH Industrial
Maquinaria Spain, S.A.
Avenida Aragón 402
28022 Madrid - ESPAÑA

CNH Industrial France, S.A.
16-18 Rue des Rochettes
91150 Morigny-Champigny
FRANCE

CNH Industrial Italia Spa
Lungo Stura Lazio 19
10156, Torino
ITALIA

CASE Construction Equipment
Cranes Farm Rd
Basildon - SS14 3AD
UNITED KINGDOM

NOTE: Standard and optional fittings can vary according to the demands and specific regulations of each country. The illustrations may include optional rather than standard fittings - consult your Case dealer. Furthermore, CNH Industrial reserves the right to modify machine specifications without incurring any obligation relating to such changes.

Conforms to directive 2006/42/EC

CASECE.COM
00800-2273-7373

The call is free from a land line.
Check in advance with your Mobile Operator if you will be charged. Toll free number not available from all calling areas.